

FAD SERIES 3

ALL BEARING FLAT ANGLE DRILLS

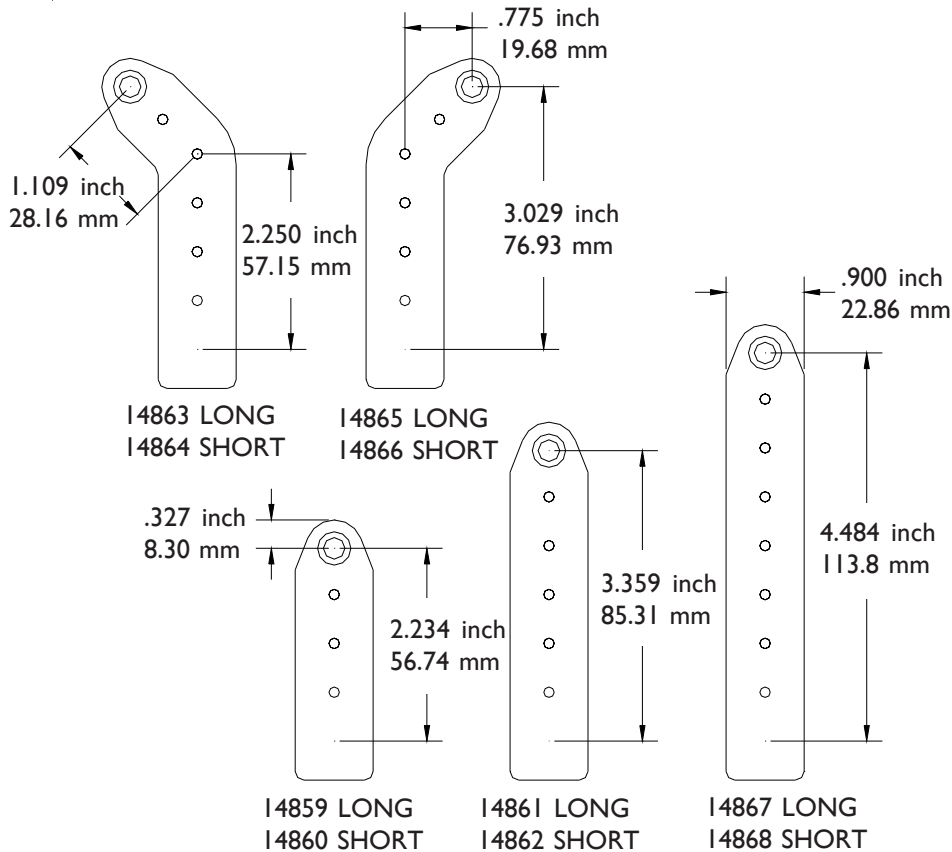

FOR .250 or 7 mm CHUCKS
AND BALL LOCK ADAPTERS

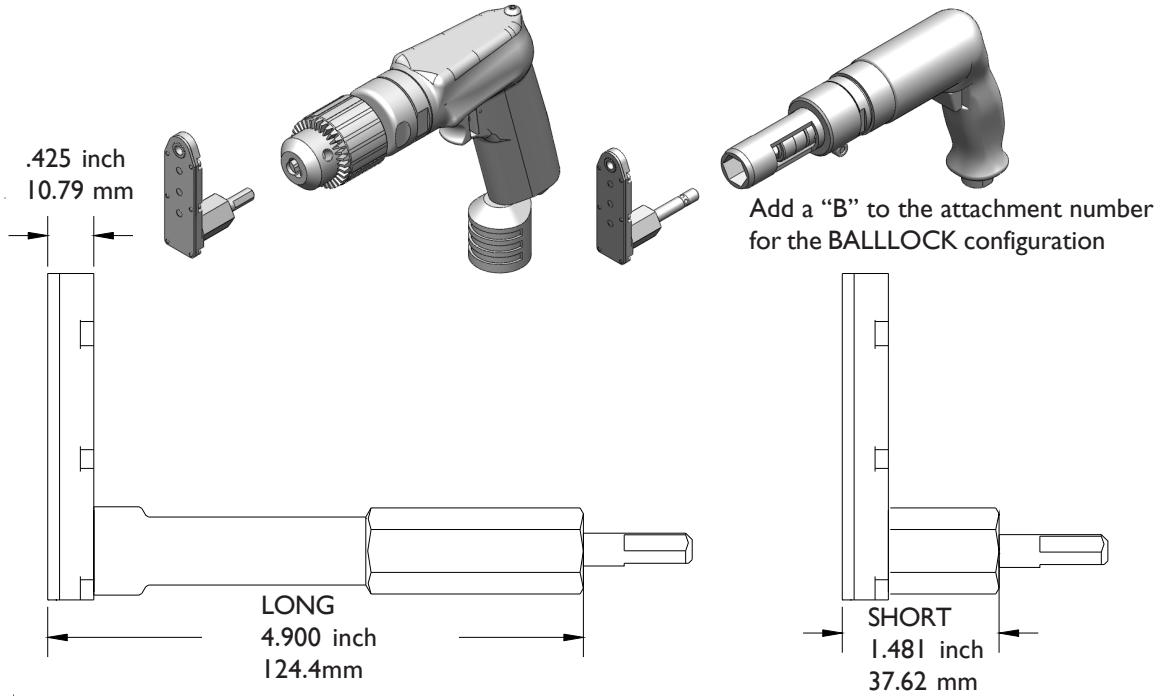

You must select an
internal thread

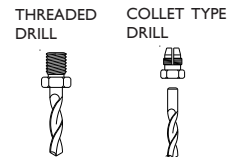

INTERNAL THREAD CODE	
1/4-28	A
10-32	C
9/32-40	E
5/16-24	F
7mm COLLET	D

PHONE: 775 883 1072 FAX: 775 883 4857